

National People's Army
of the German Democratic Republic

Literature #: 94/75

A 250/1/109

9mm Makarov¹ Pistol

Description and Use

1975

Translation by Karl F. Bloss
Copyright © 2004, Makarov.com, LLC

¹ The German phonetic spelling of Makarov is "Makarow". We have chose to use the anglicized spelling of "Makarov" throughout this translation.

Introductory Regulation to A 250/1/109

The manual 250/1/109 - 9mm Makarov Pistol, Description and Use - is issued and becomes valid on 12/1/1975. Simultaneously A 250/1/109 *A 055/1/109) - 9mm Makarov Pistol (PM), Description and Use - Issue year 1973, is no longer valid.

O.U.², July 12, 1975

Deputy of the Head
of Ground Forces
and Head of Education

² According to German dating practice, "O.U." refers to a place, which is unknown to the translator.

Table of Contents

	Page
FOREWORD TO THE TRANSLATION	7
1. BATTLE PROPERTIES AS WELL AS TACTICAL AND TECHNICAL DATA	8
1.1 Battle properties	8
1.2 Tactical and technical data	8
2. CONSTRUCTION OF THE PISTOL	10
2.1 General	10
2.2 Frame with Barrel and Trigger Guard	12
2.3 Slide with Firing Pin, Extractor, and Safety	14
2.4 Recoil Spring	18
2.5 Trigger and Striker Assembly	18
2.6 Grip	22
2.7 Slide Lock	23
2.8 Accessories	27
3. DISASSEMBLY AND ASSEMBLY	31
3.1 General	31
3.2 Partial Disassembly	31
3.3 Complete Disassembly	35
4. INTERACTION OF THE PARTS	42
4.1 State of the Parts Prior to Loading	42
4.2 Interaction of Parts During Loading	42
4.3 Interaction of Parts when Moving Safety to "Safe"	44
4.4 Interaction of Parts during Firing	44
4.5 Interaction of the Parts after the Shot	45
4.6 Interaction of Parts when Shooting Double Action	45

4.7	Interaction Parts when Exhausting Magazine Contents	46
5.	STOPPAGES WHILE FIRING AND THEIR RESOLUTION	47
5.1	General	47
5.2	Measures for Prevention of Stoppages	47
5.3	Stoppages, their Cause and Resolution	47
6.	INSPECTIONS	50
6.1	General	50
6.2	Inspection before Active Duty	51
6.3	Inspection during Active Duty	53
6.4	Inspection of the Cartridges	54
6.5	Preparation of the pistol for firing	54
7.	MAINTENANCE AND STORAGE	55
7.1	General	55
7.2	Inspection after active duty	55
7.3	Cleaning and Lubrication	55
7.4	Periodic Maintenance	57
7.5	Technical Maintenance No. 1	57
7.6	Technical Maintenance No. 2	60
7.7	Storage of the Pistol and the Cartridges	60
8.	ADJUSTMENTS AND SIGHTING	61
8.1	General	61
8.2	Adjustment	61
8.2.1	General	61
8.2.2	Principle of Sighting	61
8.3	Live Fire Sighting	62
8.3.1	General	62
8.3.2	Live Fire Sighting Conditions for Pistol M	62
9.	HANDLING OF THE PISTOL WHILE SHOOTING	64
9.1	General	64

9.2	Direct Preparation for Shooting	64
9.2.1	Filling the Magazine	64
9.2.2	Positions (Stances) for Shooting	65
9.3	Opening Fire and Ceasing Fire	67
9.3.1	Opening Fire	67
9.3.2	Ceasing Fire	69
9.4	Shooting from Cover Freehand and with Pistol Rest	71
10.	RULES OF SHOOTING	73
10.1	General	73
10.2	Selection of Location, Target, and Hold Point	73
10.3	Shooting at Night and with Limited View as well as under Influence of Chemical Agents	74

Foreword to the Translation

The translation of the East German "9mm-Pistole Makarow Beschreibung und Nutzung" was undertaken to allow English-speaking Makarov pistol collectors, particularly those who own the East German "Pistole M," to read an authentic rendition of the original manual.

Great care has been taken to translate each sentence nearly verbatim without jeopardizing the meaning of the sentence and section. This sometimes led to awkward sentence structure. Those who understand both English and German will be able to appreciate this juxtaposition of meaning and structure.

We also sought to preserve the overall layout of the manual by incorporating nearly original text style, page content, and illustrations.

While this manual is interesting both from a practical and a historical standpoint, its primary distinction from more modern manuals dealing with the Makarov pistol is its close adherence to the original manual. We also believe it gives insight into the East German state-centralized philosophy and structure.

Karl F. Bloss
March 2004

1. Battle properties as well as tactical and technical data

1.1 Battle properties

The 9mm pistol type Makarov³ (Picture 1.1) is a handgun. The intended use is for fighting the opponent at short range. The pistol can only be fired semi-automatic. The practical rate of fire is 30 shots per minute. The optimal distance of fire is up to 50 meters. The pistol shoots 9mm⁴ pistol cartridges⁵. The lethal range of the projectile extends to 350 meters.



Picture 1.1 Overall view of the pistol.

1.2 Tactical and technical data

Mass of the unloaded pistol	730 g
Mass of the pistol with loaded magazine	810 g
Length of the pistol	161 mm
Height of the pistol	127 mm

³ (Original footnote) Hereafter referred to as pistol.

Note that the caliber refers to the 9mm Makarov caliber (9x18 Makarov) and NOT the NATO 9mm, also called 9mm Parabellum, 9mm Luger, and 9x19. The latter caliber should never be fired from a Makarov pistol chambered in the original 9mm Makarov. For more detailed information, see <http://makarov.com/makfaq.html>

⁵ (Original footnote) Hereafter referred to as cartridges..

Length of the barrel	93 mm
Caliber	9 mm ⁶
Number of barrel riflings	4
Magazine capacity	8 cartridges
Mass of the cartridge	10 g
Mass of the projectile	6.1 g ⁷
Length of the cartridge	25 mm
Muzzle velocity (V_0)	315 m/s ⁸

⁶ Note that the caliber refers to the 9mm Makarov caliber (9x18 Makarov) and NOT the NATO 9mm, also called 9mm Parabellum, 9mm Luger, and 9x19. The latter caliber should never be fired from a Makarov pistol chambered in the original 9mm Makarov. For more detailed information, see <http://makarov.com/makfaq.html>

⁷ Unit is grams. This is ~ 94 grains.

⁸ 1033 ft/sec

2. Construction of the pistol

2.1 General

The pistol is simple in construction and handling. It is a self-loading weapon, that reloads automatically after each shot.

The functionality of the weapon is based on the principle of the recoil of a free-floating mass closure⁹. The breech is reliably closed after delivery of the shot by the action of the recoil spring. The trigger mechanism has an easy and a hard pull. The hard pull (trigger cocking) allows the pistol to be shot without first cocking the hammer.

Shooter safety is accomplished by a reliable manual safety at the left side of the slide. After the safety releases the hammer, the hammer falls into a safe position. The hammer rotates by action of the wide angled end of the hammer spring¹⁰ in an angle to the slide (this is also called "decocked hammer"), such that the tip of the sear seats into a safety notch on the hammer. After release of the trigger, the trigger bar is pushed to the rearmost position by the narrow tip of the hammer spring. The disconnecter and sear lower and under pressure from the sear spring, the sear is pushed against the hammer; thereby the hammer is automatically secured.

When ordered to shoot, the trigger is activated. Thereby the hammer hits the firing pin. The firing pin pierces¹¹ the primer; thereby the priming charge is ignited. By pressure of the gases created by burning powder, the projectile is pushed out of the barrel. Simultaneously, the slide moves rearward due to the pressure of the powder gases that are acting on the slide via the cartridge base.

During this series of events, the empty shell is pulled from the chamber by the extractor and the recoil spring is compressed. Once the it impacts the ejector, the shell is ejected from the pistol via the ejection port in the slide.

⁹ This is a reference to an unlocked breech blowback operation, as opposed to a locked breech recoil system.

¹⁰ Refers to the main spring, not the recoil spring.

¹¹ Although the word "pierces" is used, the firing pin crushes the primer.

The motion of the slide rotates the hammer to its rearmost position and cocks it.

Once the slide has traveled back to impact [with the frame¹²], the slide begins traveling forward by action of the compressed recoil spring. During the forward motion, the slide pushes the next cartridge from the magazine and guides it into the chamber. The breech is locked by an inertial lock. The pistol is ready for continued firing.

To deliver the next shot, the trigger must be released and then activated again. The firing can be continued in this order of operation until all cartridges have been shot from the magazine. Once the last shot has been fired, the slide is held in the rearmost position by the slide lock.

The pistol is composed of the following main parts (Picture 2.1):

- Frame with barrel and trigger guard,
- Slide,
- Recoil spring,
- Trigger and striker assembly,
- Grip,
- Slide lock,
- Magazine.

Accessories include:

- Spare magazine,
- Cleaning kit¹³,
- Holster,
- Lanyard¹⁴.

¹² This is implied, but the real impact is with the front of the trigger guard.

¹³ (Original footnote) The cleaning apparatuses are differentiated:

- Soviet version - combined cleaning rod
- GDR version - RG-57.

¹⁴ (Original footnote) In place of the braided lanyard, the Soviet manufacture uses a leather lanyard.

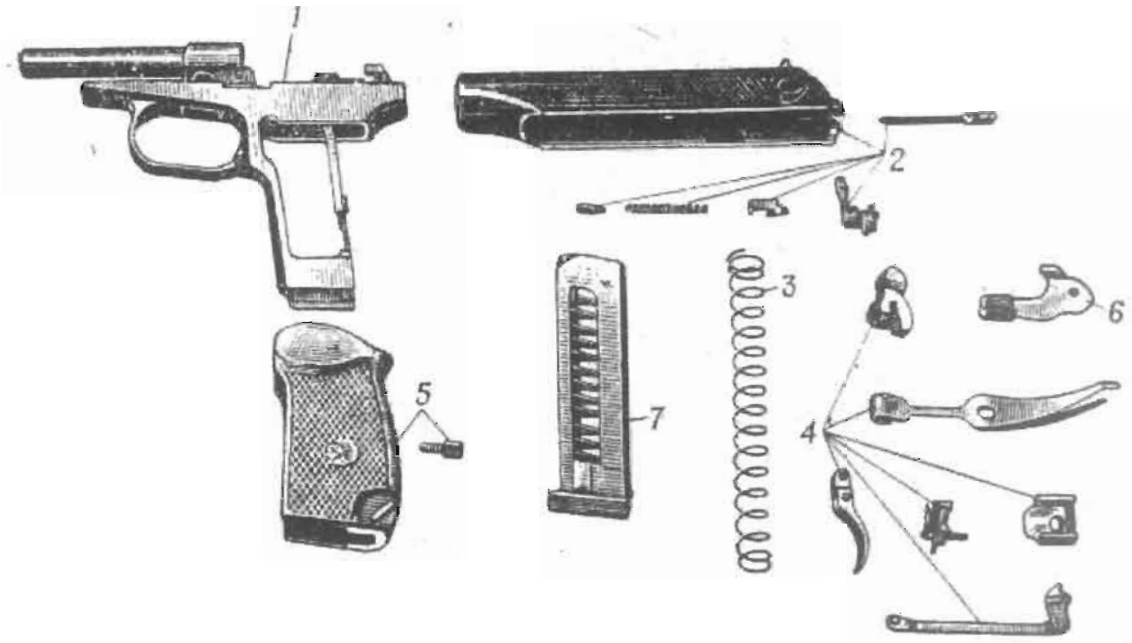

Picture 2.1 Parts of the Pistol

1 - Frame with barrel and trigger guard; 2 - Slide with firing pin, extractor, and safety; 3 - Recoil spring; 4 - Pieces of the Trigger- and Striker assembly; 5 - Grip with grip screw; 6 - Slide lock; 7 - Magazine

2.2 Frame with Barrel and Trigger Guard

The barrel imparts the projectile direction, rotation, and velocity. There are four grooves cut into the barrel, which run from bottom left to top right¹⁵ and give the projectile its rotation about the longitudinal axis. The remaining pieces are the lands. The caliber is measured from land to land. It amounts to 9 mm¹⁶. The barrel is subdivided into the chamber and rifled portion. There is a step in the chamber.

At the mouth of the barrel is a widened portion for attachment to the frame as well as a drilled hole for the barrel pin.

At the mouth of the barrel and at the bottom of the chamber is a slanted portion¹⁷, which gives the cartridge the required direction into the chamber during feeding.

¹⁵ Clockwise.

¹⁶ The actual bore diameter is 0.363-0.365", which is approximately 9.2 mm.

¹⁷ Feed ramp

The outer surface of the barrel is smooth. The recoil spring is pushed onto the barrel.

The barrel is pressed into the barrel sleeve and is held in the frame by the barrel pin.

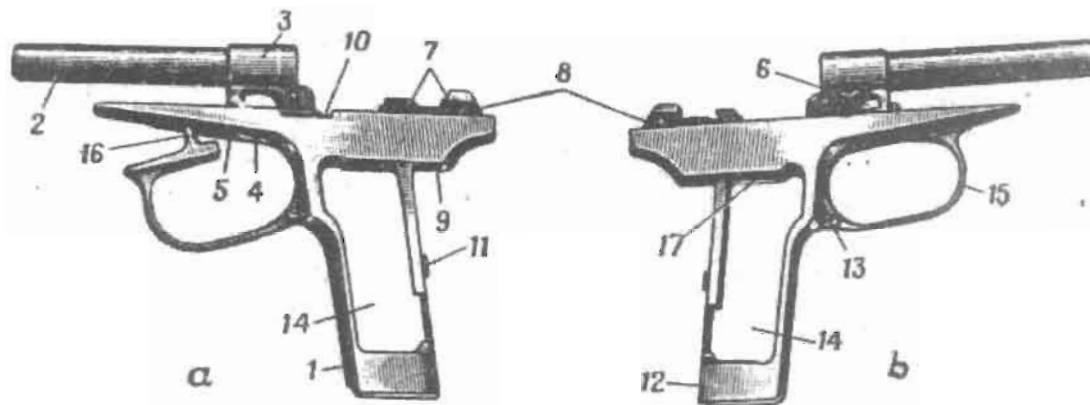

Picture 2.2 Frame with Barrel and Trigger Guard

a - left side; b - right side

1 - Frame; 2 - Barrel; 3 - Barrel sleeve; 4 - Opening for trigger; 5 - Bearing surface for trigger detents; 6 - Half-round slot for connection of trigger bar with trigger; 7 - Bearing for hammer detents; 8 - Slot for slide movement; 9 - Opening for main spring tips; 10 - Cutout for slide lock; 11 - Threaded hole for grip screw; 12 - Cutout for magazine lock; 13 - Attachment point with bearing for trigger guard; 14 - Side openings; 15 - Trigger guard; 16 - End of trigger guard to limit rearward motion of slide; 17 - Opening for upper part of magazine

The Frame connects all parts of the pistol. It is fabricated from a single piece.

In the forward portion are:

top - the barrel sleeve,

bottom - Opening for trigger and attachment point with bearing for trigger guard.

On the side planes of this opening are the bearings for the trigger rotation pins.

The barrel sleeve has a drilled opening for accepting the barrel at the top and an opening for the top of the trigger at the bottom as well as a half round groove for accepting the front pin of the trigger bar at the right.

In the rear portion are:

top - bearings for accepting the hammer pivot pins and sear pins as well as grooves for slide movement (the pin bearings for the hammer and the right pin bearing for the sear have cut outs),
bottom - Opening for the tips of the hammer spring.

In the middle portion we find:

- an opening for the top of the magazine,
- on the left side a cut out for the slide lock.

The grips and hammer spring are attached to the frame. The frame accepts the magazine.

A threaded hole for accepting the grip screw is on the back wall. The threaded hole is reinforced such that the main spring is attached with a spring retention clip.

At the bottom is a cut out for the magazine release. At the front is a bearing and attachment point for the trigger guard.

The trigger guard prevents unintentional activation of the trigger. At the front of the trigger guard is a reinforced portion that limits the movement of the slide. The trigger guard is held up by a plunger and spring, which are located in the front wall of the frame.

2.3 Slide with Firing Pin, Extractor, and Safety

The Slide (Picture 2.3) feeds the cartridge into the chamber, closes the breech, ignites the cartridge, extracts and ejects the shell (cartridge), and cocks the hammer.

On the outside of the slide are the following:

- on the top plane are the front sight, a crosswise groove for acceptance of the rear sight, a checkered strap between front and rear sight to avoid reflective glare;
- on the right side an ejection port, the cutout for the extractor, extractor with spring and plunger;
- on the left side a cut out for the safety pivot pin, a flat planed area for the safety and a recesses for the positioning of the safety. The safety detent spring grips the recesses and holds the safety at the appropriate position:

upper position	= "safe"
lower position	= "fire";

- on both sides the outer surface is slotted for better grip while retracting the slide;
- on the back is a cut out for the the hammer.

On the inside of the slide are:

- the cutout for the barrel with recoil spring, the guide rails, a detent to lock the slide open with the slide lock, and the comb¹⁸.
- the cutout for the ejector, the cutout for the disconnector, the cutout for the disconnector when trigger has been pulled;
- the ejector and the surface to separate the disconnector from the sear.

On the right side of the edge of the slide is a cutout intended for release of the sear from the disconnector when the slide is released via the slide lock and the trigger is pulled.

In the comb is a drilled hole for the firing pin¹⁹.

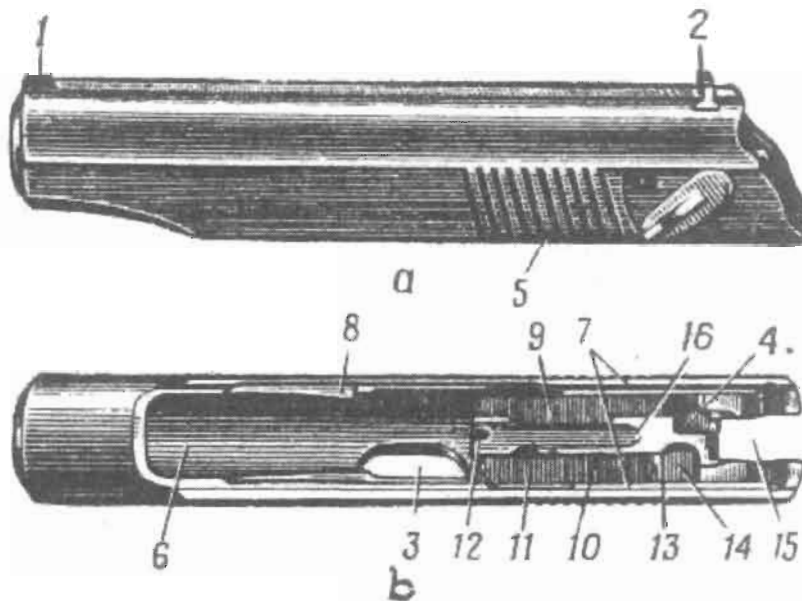

Picture 2.3 Slide

¹⁸The "comb" is the raised area that holds the firing pin and strips cartridges from the magazine.

¹⁹Firing pin channel.

a - left side; b - View from bottom

1 - front sight; 2 - rear sight; 3 - ejection port; 4 - cutout for the safety; 5 - grip surface; 6 - cutout for the barrel and recoil spring; 7 - guide rails; 8 - slot for locking the slide with the slide lock; 9 - cutout for the ejector; 10 - the cutout for the disconnecter; 11 - the cutout for the disconnecter when trigger has been pulled; 12 - ejector; 13 - surface to separate the disconnecter from the sear; 14 - cutout for release of the sear from the disconnecter when the slide is released via the slide lock and the trigger is pulled; 15 - cutout for the hammer; 16 - comb

The firing pin (Picture 2.4) serves to pierce the primer. At the front is the tip of the firing pin. The firing pin is flattened at the rear so the safety holds the firing pin in the firing pin channel.

The firing pin is machined with a triangular cross section to minimize friction.



Picture 2.4 Firing Pin

The extractor (Picture 2.5) pulls the shell (cartridge) out of the chamber and holds it until impact with the ejector. It has an extraction claw and a tip. The tip serves as a connection to the slide. At the rear of the tip is a dimple for the extractor pin.

At the rear of the extractor is a cutout for compression of the extractor pin and spring with an object (cleaning rod) during removal of the extractor from the slide.

The extractor pin is reinforced at the tip. The front of the extractor spring (the part with the smaller diameter) rests on this piece. The extractor spring is a compression spring and gives the extractor its spring loading.



Picture 2.5 Extractor

1 - extractor claw; 2 - tip for connection to the slide; 3 - extractor pin; 4 - extractor spring

The safety (Picture 2.6) guarantees safety when handling the pistol.

It consists of

- the safety lever to switch the safety from the "safe" position to the "fire" position and vice versa,
- the detent spring to maintain the safety in the selected position,
- the rotation pin with cutout for lifting the sear and to release the cocked hammer when the safety is rotated to the "safe" position,
- the surface to lock the slide when in the "safe" position,
- the claw to lock the hammer when in the "safe" position,
- the pin that grips the cutout in the slide.

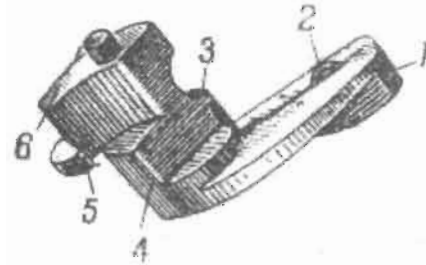

Picture 2.6 Safety

1 - safety lever; 2 - detent spring; 3 - cutout; 4 - surface; 5 - claw; 6 - pin

The rear sight, along with the front sight, is for targeting. It is pressed into the crosswise groove²⁰.

²⁰ Dovetail

2.4 Recoil Spring

The recoil spring (Picture 2.7) acts to push the slide forward. It has a tapered end with which it is pushed onto the barrel. Thereby, when the pistol is disassembled, the spring is retained on the barrel securely.



Picture 2.7 Recoil Spring

2.5 Trigger and Striker Assembly

The trigger and striker assembly (Picture 2.8) is composed of

- the hammer,
- the sear with spring,
- the trigger bar with disconnecter,
- the trigger,
- the hammer spring,
- the hammer spring clip.

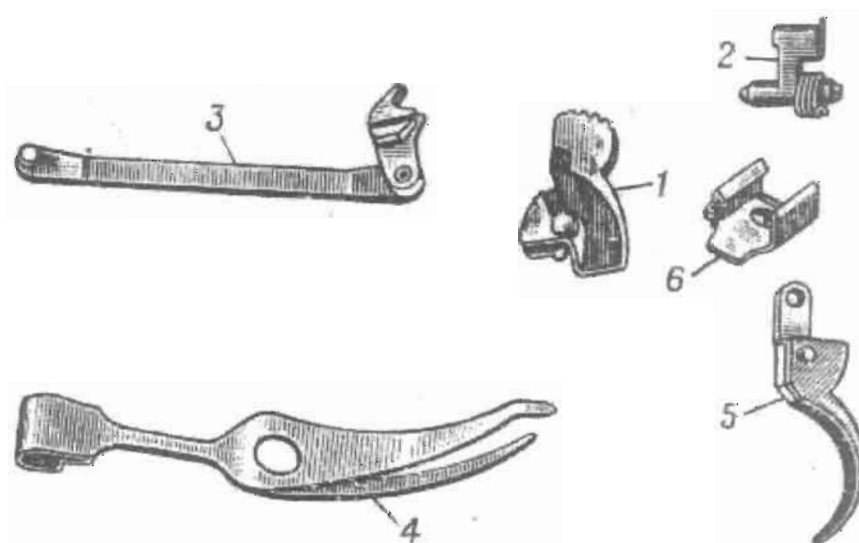

Picture 2.8 Parts of the Trigger and Striker Mechanism

1 - hammer; 2 - sear with spring; 3 - trigger bar with disconnecter; 4 - hammer spring; 5 - trigger; 6 - hammer spring retention clip

The hammer (Picture 2.9) strikes the back end of the firing pin, which ignites the cartridge.

On the hammer are:

- at the top, a corrugation for better handling;
- at the front, a cutout for free movement from release of the cocked position, a cutout for the safety claw, two sear notches (the upper is the safety notch, the lower is the cocking notch);
- lateral pins for rotation of the bearings when the hammer is inserted in the frame,
- at the right, a notch for cocking the hammer with the disconnecter;
- at the left, a notch for locking the hammer with the safety;
- at the bottom, a recess for the wide end of the hammer spring and a circular dimple for accepting the foot of the disconnecter.

The pins of the hammer are flattened to facilitate removal from the frame.

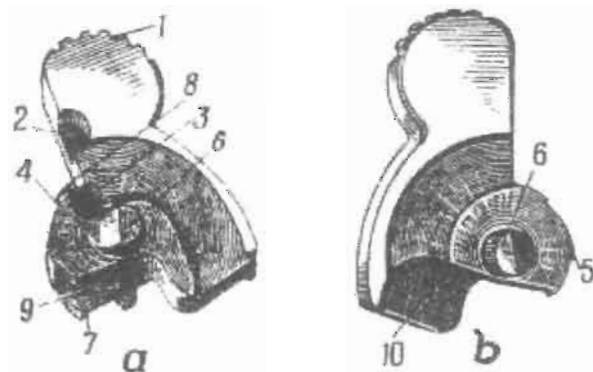

Picture 2.9 Hammer

a - left side; b - right side

1 - head with corrugation; 2 - a cutout for free movement; 3 - cutout for the safety; 4 - safety notch; 5 - cocking notch; 6 - pins; 7 - cocking notch; 8 - locking notch; 9 - recess for hammer spring; 10 - circular dimple

The sear with spring (Picture 2.10) serves to hold the hammer in the cocked or safe position.

On the sear are:

- an edge that grips the cocking and safety notches in the hammer,
- pin for connection with the frame,
- a claw for lifting the sear by the safety when switching to the "safe" position,
- a surface which mates with the disconnector during release of the hammer.

The left rotating pin has a spring pressed onto it, the tip of which is connected with a hole in the sear.

The free end of the spring is bent into a hook shape and is thereby connected with the slide lock.

The spring pushes the tip of the sear against the cocking and safety notches of the hammer. The rotating pins of the sear are flattened to facilitate removal from the frame.

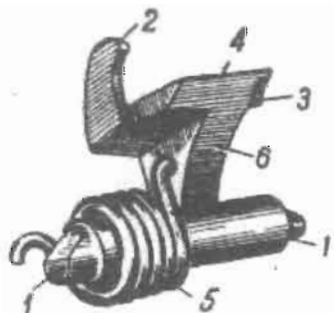

Picture 2.10 Sear with Spring

1 - pin; 2 - claw; 3 - tip for disconnector; 4 - edge for cocking and safety notches; 5 - spring; 6 - body

The trigger bar with disconnector (Picture 2.11) acts to release the hammer from the cocked position as well as cocking the hammer through activation of the trigger. At the ends of the trigger bar are pins. The front pin connects the trigger to the trigger bar, and the rear pin connects the trigger bar to the disconnector.

On the disconnector are:

- a tip that separates the disconnector and the sear during rearward motion of the slide,
- a recess for the tip of the sear,

- a tip that grips the safety notch of the hammer and cocks the hammer in double-action firing mode,
- a foot, upon which the narrow tip of the hammer spring rests.

The foot of the disconnecter rests in in the circular recess of the hammer.

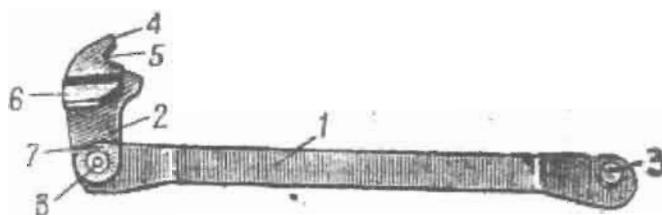

Picture 2.11 Trigger Bar with Disconnecter

1 - trigger bar; 2 - disconnecter; 3 - trigger bar pin; 4 - tip for the disconnecter; 5 - recess for the sear; 6 - tip to cock the hammer; 7 - foot of the disconnecter

The trigger (Picture 2.12) serves to release the hammer from the cocked position and for cocking the hammer when shooting double-action.

On the trigger are:

- pin for insertion into the frame bearings,
- a hole for insertion of the trigger bar pin,
- a curved portion (trigger piece) for activating the trigger.

The trigger is mounted in the frame by inserting the head piece into the frame opening.

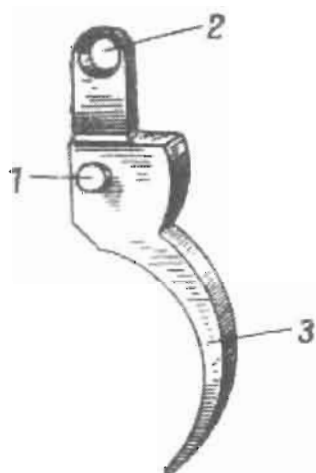

Picture 2.12 Trigger

1 - pin; 2 - hole; 3 - curved portion (trigger piece)

The hammer spring²¹ (Picture 2.13) serves as the propellant for the hammer, the disconnecter, and the trigger bar.

The hammer spring has

- a wide tip for interaction with the hammer,
- a narrow tip for interaction with the disconnecter and the trigger bar.

In the middle is a hole for attaching the hammer spring to the frame.

The bottom part acts as a magazine lock²².

The front part of the wide tip is bent to allow decocking of the hammer, that is, to secure it into the decocked state.

The hammer spring is secured to the frame with the hammer spring clip.

Picture 2.13 Hammer Spring

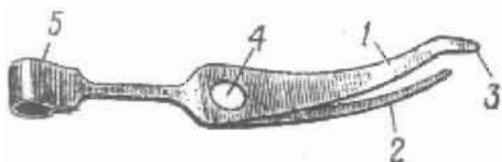

1 - wide tip; 2 - narrow tip;
3 - bent tip; 4 - hole; 5 -
magazine lock

2.6 Grip

The grip (Picture 2.14) consists of a single piece. It conceals the open sides of the frame and simplifies the handling of the pistol.

On the grips are:

- a hole for the grip screw
- a lanyard eye (only on the Soviet version) or a hole for attachment of the lanyard,
- a cutout for attachment to the frame.

On the rear wall is a recess for the magazine lock. In the grip screw hole, there is a metal socket with detents (only on the Soviet version), to prevent unintentional loosening of the grip screw.

The grip screw serves to attach the grip and the hammer spring to the frame. The screw is composed of the screw head and a threaded portion.

²¹ Also called the main spring.

²² Magazine lock = magazine release.

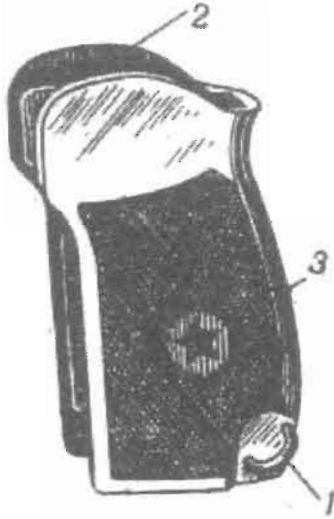
Picture 2.14 Grip with Grip Screw

1 - lanyard eye; 2 - cut out; 3 - hole; 4 - grip screw

2.7 Slide Lock

The slide lock²³ (Picture 2.15) holds the slide in its rearmost position when the last cartridge has been fired from the magazine.

On the slide lock are:

- an edge that holds the slide in its rearmost position,
- a handle with corrugations, that releases the slide when slide lock is pressed,
- a hole for connection of the left pin of the sear,
- the ejector.

The slide lock is inserted into the cut out of the left wall of the frame.

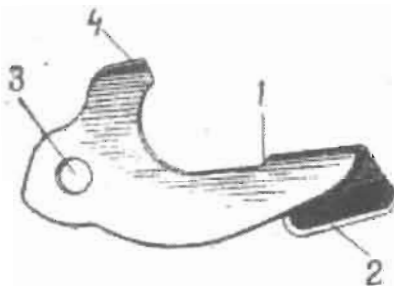
Picture 2.15 Slide Lock

1 - edge; 2 - handle with corrugations; 3 - hole; 4 - ejector

²³ Also called slide release.

Magazine

The magazine (Picture 2.16) serves to hold 8 cartridges. It consists of:

- the magazine housing
- the follower
- the follower spring
- the magazine floorplate.

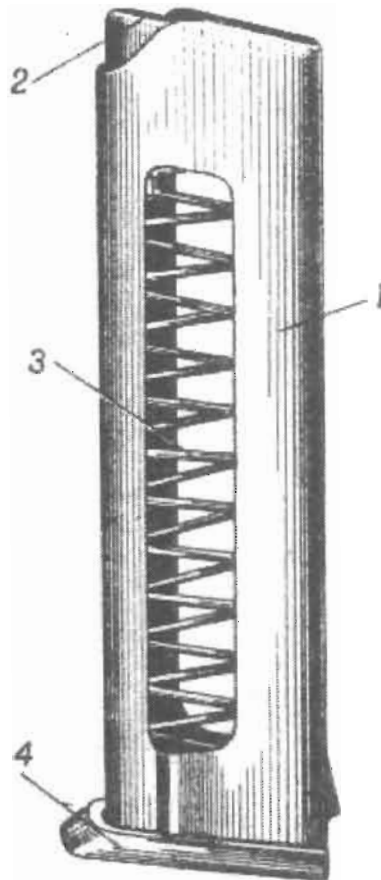

Picture 2.16 Magazine

1 - magazine housing; 2 - follower; 3 - follower spring; 4 - magazine floorplate

The magazine housing (Picture 2.17) connects the pieces of the magazine. The upper rims of the sides of the magazine housing are bent inwards in order to retain the cartridges and the follower (they are also called magazine lips). In addition, the bent rims give direction to the cartridge during feeding into the chamber.

On the magazine housing are:

- side cutout that makes it possible to count the cartridges in the magazine,
- an angled rim onto which the magazine floorplate is pushed,
- a tab for the magazine lock,
- a cutout for the left wall of the magazine floorplate,
- a projection for the follower tab.

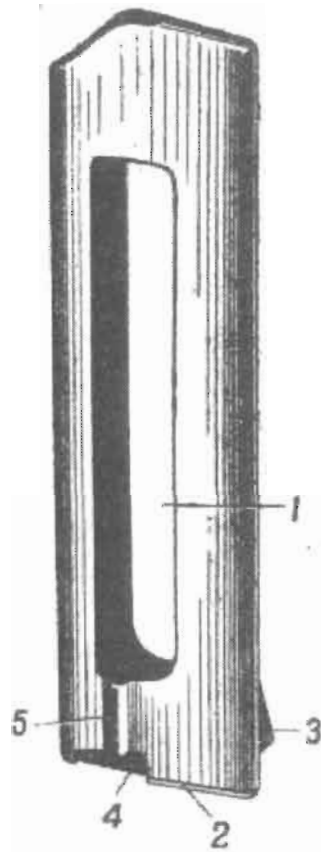

Picture 2.17 Magazine Housing

1 - side cut out; 2 - angled rim; 3 - tab; 4 - cutout; 5 - projection

The follower (Picture 2.18) feeds the cartridges. It has two angled ends for guidance in the magazine housing. On the leftmost of the angled ends is a tab that, after firing of the last cartridge, pushes the slide lock up.

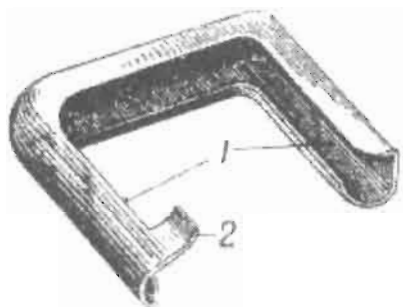
Picture 2.18 Follower

1 - angled ends; 2 - tab

The follower spring (Picture 2.19) is a compression spring. It pushes the follower and thereby the cartridges in the magazine upwards. The bottom of the follower spring is angled and rests in the slot of the magazine floorplate.

Picture 2.19 Follower Spring

The magazine floorplate (Picture 2.20) closes the magazine housing at the bottom. It has a slot for accepting the angled end of the magazine spring and guidance grooves for sliding it onto the the magazine housing.

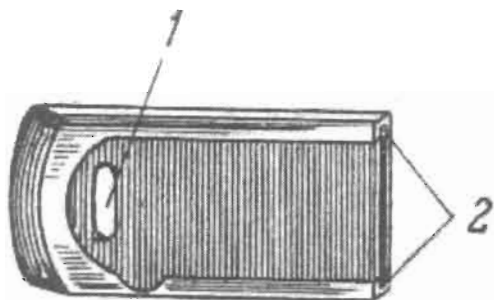
Picture 2.20 Magazine Floorplate

1 - slot; 2 guidance grooves

2.8 Accessories

Accessories for the pistol include:

a) GDR Version

- spare magazine,
- cleaning apparatus (RG-57),
- holster,
- lanyard;

b) Soviet Version

- spare magazine,
- combination cleaning rod,
- holster,
- lanyard.

The spare magazine holds 8 cartridges. It is stored in the spare magazine pocket in the holster.

The cleaning kit (RG-57) is used for the disassembly, cleaning, lubrication, and assembly of the pistol.

It consists of

- the container,
- the oil can,
- the radial cleaning brush,
- the pipette brush,
- the in-line cleaning brush,
- the pull-through,
- the screwdriver,
- the oil brush,
- the protective sleeve for the oil brush,
- the pull-through weight,
- the cleaning cord,
- the bag for the cleaning kit,
- the cleaning patches,
- the cover and cleaning cloth.

The combination cleaning rod is used for the disassembly, cleaning, lubrication, and assembly of the pistol.

On the rod is:

- a tip for removal and installation of the sear spring hook as well as removal and installation of the extractor.
- an opening for the cleaning patches and the cleaning cloth,

- a ring for improved handling.

On the end of the ring is a bent piece is intended for removal and installation of the grip screw.

The holster is used to store the pistol and spare magazine (the Soviet version also stores the cleaning rod).

It consists of

- the holster body,
- the cover flap,
- the pocket for the spare magazine,
- the belt loop (the Soviet version has two belt loops),
- the closure,
- additionally, the Soviet version has loops for the cleaning rod and straps to aid in lifting of the pistol.

The lanyard is used to secure the pistol to the belt loop.

It consists of:

- the strap,
- the carabiner hook,
- the belt loop.

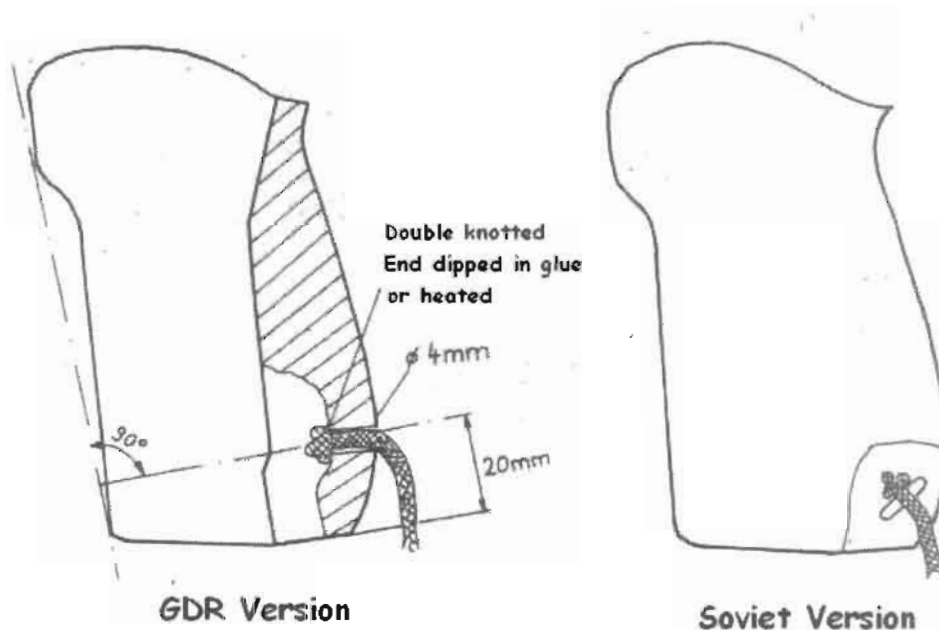

Picture 2.21 Attachment of the Lanyard to the Grip

The lanyard is used for secure attachment of the pistol to the belt loop, the uniform of the pistol wearer or a carry case worn underneath the jacket. The attachment of the lanyard to the pistol is depicted in picture 2.21.

Depending on the mode of carry, the pistol is to be attached as follows:

a) On the holster:

The attachment loop of the lanyard should be attached to the belt loop, as shown in picture 2.22.

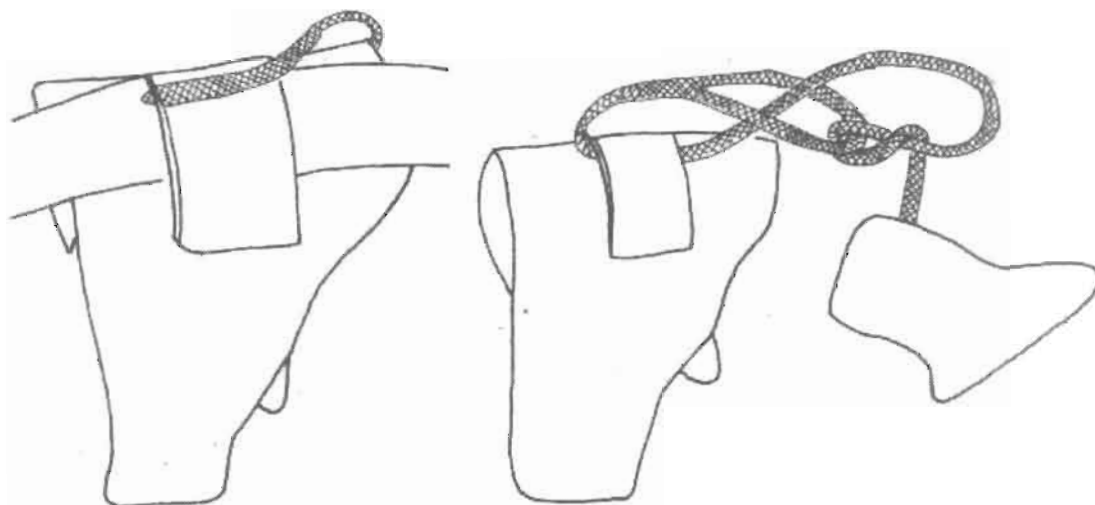

Picture 2.22 Using the Attachment Loop and Mode of Carry on the Belt Loop

b) In the the front inside pocket of the field uniform, summer/winter:

The attachment loop of the lanyard is secured to the button hole of the front inside pocket of the jacket. The lanyard slack is taken up by storing it in the pocket.

c) In the carry case under the jacket:

The attachment loop of the lanyard is secured to the carry strap of the carry case. The lanyard slack is taken up by storing it in the carry case.

d) In the outer clothing articles, in which a pocket for the pistol has been sewn, the lanyard is secured as in letter (b):

- battle uniform for reconnaissance/airborne troops,
- technical staff suit,
- work suit, lined,
- suit for tank troops.

The lanyard shall be stowed in such a way in the named pockets, such that the pistol can be drawn quickly and unhindered and is immediately available for use. When stored in the pistol case, the lanyard shall be wrapped around the frame.

3. Disassembly and Assembly

3.1 General

The pistol can be disassembled partially and completely.

The partial disassembly follows:

- at maintenance after duty,
- at routine maintenance and, when necessary, at inspection before duty.

The complete disassembly follows after maintenance # 1, after firing and for cleaning the pistol after severe dirt contamination or when the pistol received long-term exposure to rain or snow.

It is not permitted to completely disassemble the pistol without sufficient reason, to avoid premature wear of the parts and assemblies. During disassembly and reassembly, the following rules are to be observed:

- The pistol shall be disassembled and reassembled on a clean surface, both when on a table and in the field.
- The pieces and assemblies shall be layed out in the order than they were disassembled.
Do not use unnecessary force or hard raps.
- When reassembling, do not mix up parts of other pistols (observe the numbering of the pieces).

3.2 Partial Disassembly

The pistol is partially disassembled as follows:

- a) Remove magazine from the frame (Picture 3.1).
 - Hold the pistol with the right hand on the grip.
 - Press the magazine lock with the left thumb until it impacts the frame and pull the magazine out with the index finger.
 - Remove the magazine from the frame.
 - Turn safety lever to "fire" and ensure than no cartridge remains in the chamber (pull slide back with left hand inspect the chamber).
 - Release slide.



Picture 3.1 Removal of Magazine from the Frame

- b) Remove slide from frame (Picture 3.3).
- Grasp pistol with right hand on the grip.
 - Pull the trigger guard down with the left hand, push to the left and hold in this position with the index finger of the right hand (Picture 3.2).



Picture 3.2 Pull Down Trigger Guard

- Pull slide back to rearmost position and lift rear of slide (Picture 3.3).
- Allow raised slide to be pushed forward slowly by the force of the recoil spring and remove from frame.
- Return trigger guard to original position.

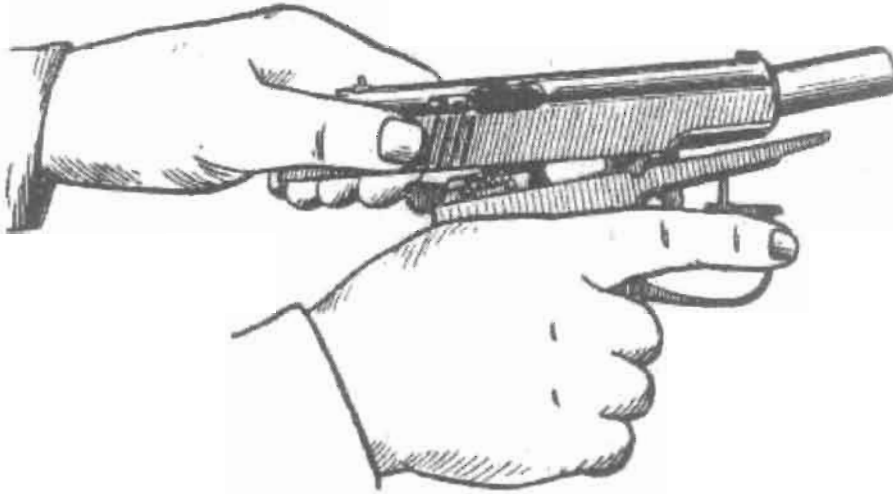

Picture 3.3 Removal of Slide from Frame

c) Remove recoil spring from barrel.

- Grasp pistol with right hand on the grip.
- Pull recoil spring from barrel.

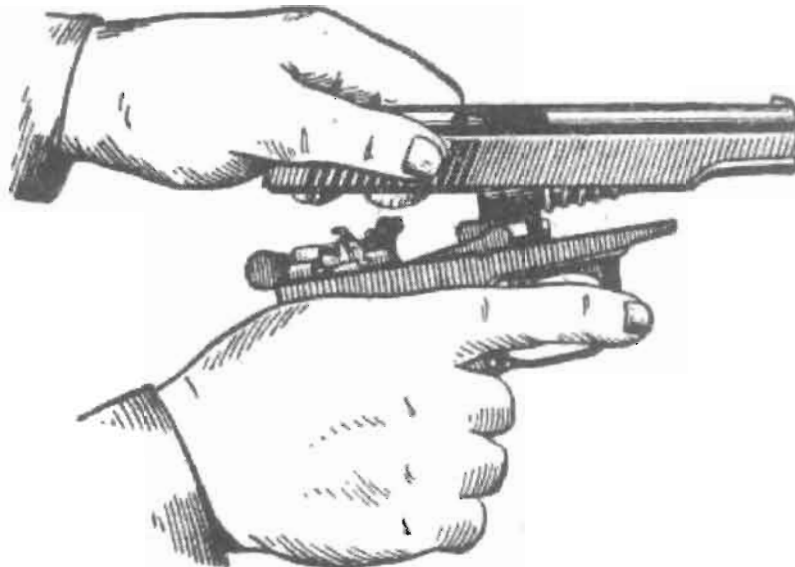

Picture 3.4 Introduction of the Free End of the Recoil Spring into the Slide Channel

The pistol is reassembled in reverse order.

Note:

The recoil spring is pushed over the barrel with the smaller diameter opening.

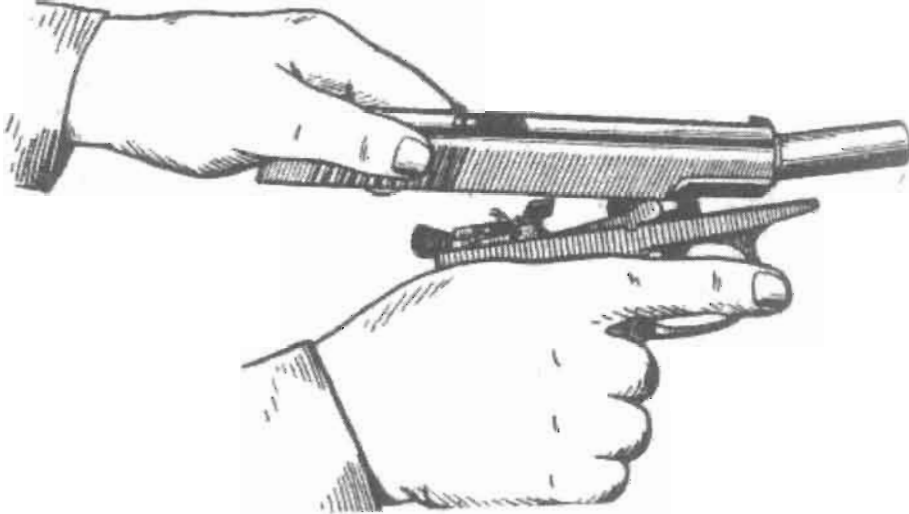

Picture 3.5 Replacement of the Slide onto the Frame



Picture 3.6 Insertion of the Magazine into the Frame

The correct assembly of the pistol after partial disassembly is verified as follows:

- Rotate safety lever to "fire".
- Pull slide back until it stops and release. The slide must be held back by the slide lock after slight forward movement.
- Release the slide by pushing on the slide lock with right thumb. The slide must move forward quickly under pressure from the recoil spring. The hammer must stay cocked.
- Rotate safety lever to "safe". The hammer must decock and then stay locked.

3.3 Complete Disassembly

The pistol is completely disassembled as follows:

- a) Partially disassemble pistol (Section 3.2).
- b) Remove sear and slide lock from frame.
 - Take pistol into left hand and decock hammer. While holding the hammer with the left hand, activate trigger and let hammer come forward slowly.
 - With the sharp end of the pull-through weight of the cleaning pull-through (the cleaning rod), lift off the sear spring hook from the slide lock (Picture 3.7).
 - With the thumb and index finger, rotate the sear such that the flattened area on the right sear pin matches with the cut out in the slide.
 - Lift sear and slide lock up and out of the frame (Picture 3.8).



Picture 3.7 Removal of the sear spring hook from the slide lock

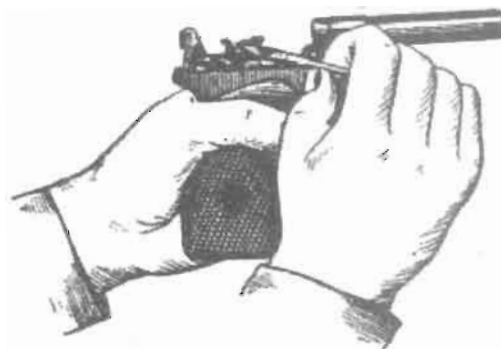

Picture 3.8 Removal of the hammer and slide lock from the frame

c) Remove grip and hammer spring from frame.

- Using the screwdriver in the cleaning kit, remove the grip screw.
- Pull grip off to the rear (Picture 3.9).
- Push the hammer spring towards the frame with the left thumb, and push the main spring clip down and off.
- Remove hammer spring (Picture 3.10).

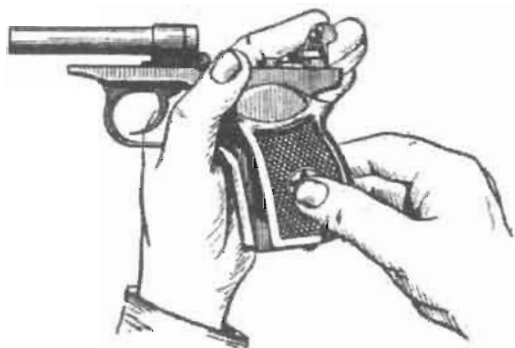

Picture 3.9 Removal of the grip from the frame



Picture 3.10 Removal of the hammer from the frame

Note:

If no screwdriver is available under field conditions, the grip screw can be removed with the ejector on the slide lock.

d) Remove hammer.

- Hold frame in left hand and bring trigger to forward position.
- Rotate hammer forward with thumb and index finger such that flattened portion of the hammer pin aligns with the cutout on the frame hammer pin bearing.
- Remove hammer forwards (Picture 3.11).

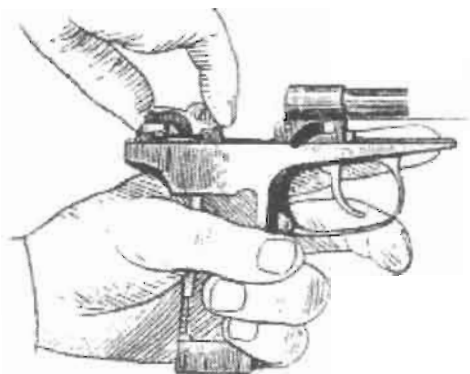

Picture 3.11 Removal of hammer from frame

e) Remove trigger bar with disconnecter from frame.

- Hold frame in left hand.
- Lift rear of trigger bar with right hand (Picture 3.12).
- Pull pin out of hole in trigger.

f) Remove trigger from frame.

- Hold frame in left hand.
- Unseat trigger guard with right hand.
- Rotate trigger forwards.
- Remove trigger pins from trigger pin bearings and remove trigger from frame.
- Reseat trigger guard to its original position.



Picture 3.12 Removal of trigger bar with disconnecter from frame

g) Remove safety and firing pin from slide.

- Hold slide in left hand.
- Push safety lever up with the right thumb.
- Continue rotating safety lever with thumb and index finger of the right hand (Picture 3.13).
- Remove safety from bearing.
- Strike rear of slide gently onto palm and remove firing pin from slide.

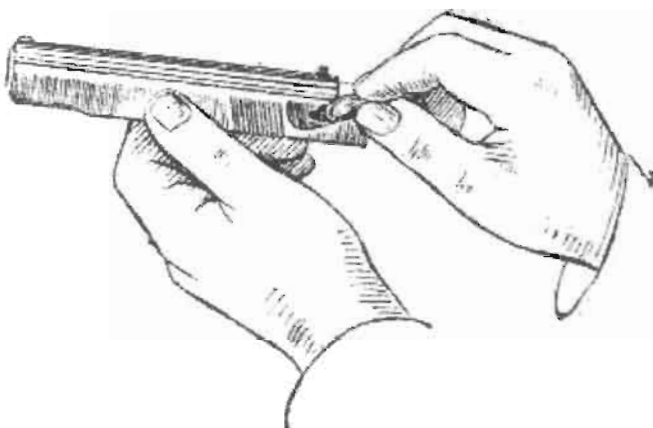

Picture 3.13 Removal of safety from slide

h) Remove extractor from slide.

- Hold slide in left hand.
- With the sharp end of the pull-through weight (the cleaning rod), push inwards against the extractor plunger.
- Simultaneously push down on the forward part of the extractor and remove the extractor forwards.
- Remove spring and pin from hole.

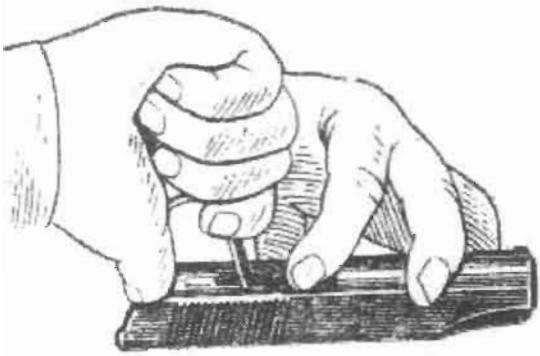

Picture 3.14 Removal of extractor from slide

i) Magazine disassembly.

- Hold magazine in left hand.
- Push follower spring towards the follower with the thumb and index finger of the left hand (Picture 3.15).
- Slide off magazine floorplate with the right hand.
- Remove follower spring and follower from the magazine.

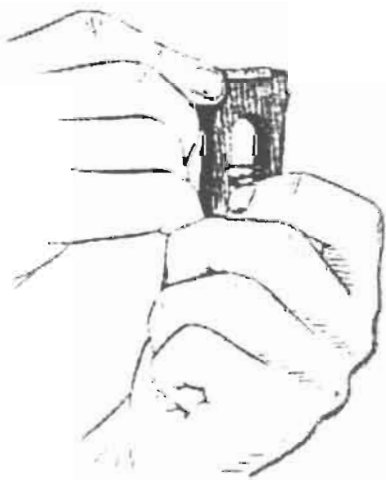

Picture 3.15 Disassembly of magazine

The pistol should be reassembled in reverse order. It is especially noted that during insertion of the hammer spring, the wide portion of the hammer spring contacts the recess in the hammer and the narrow portion contacts the foot of the disconnecter. The correct insertion of the hammer spring is to be tested; activate the trigger lightly several times. If the hammer goes back, the hammer spring is inserted correctly.



Picture 3.16 Assembly of the magazine



Picture 3.17 Insertion of the extractor into the slide

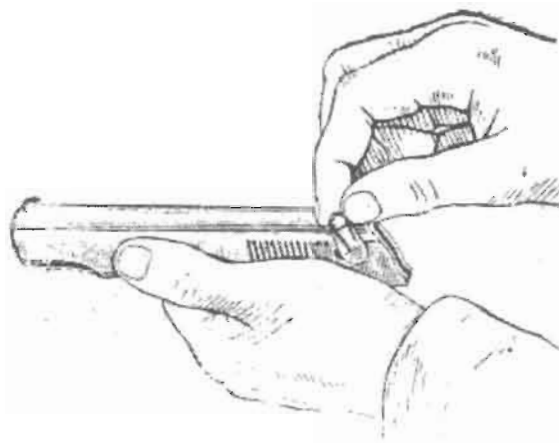

Picture 3.18 Insertion of the safety into the slide



Picture 3.19 Insertion of the hammer into the frame

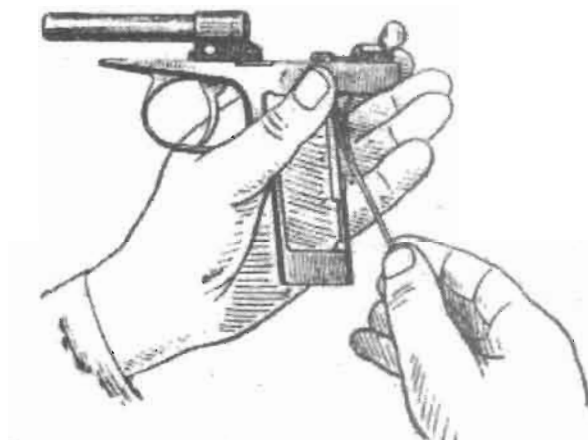

Picture 3.20 Attachment of the hammer spring to the frame



Picture 3.21 Securing the hammer spring with the hammer spring clip



Picture 3.22 Insertion of the slide lock and the sear into the frame

Note:

It is forbidden to cock and release the hammer with the trigger before the hammer has been firmly seated into the frame.

The pieces of the pistol are to be tested for proper function after assembly, as described in section 6.2.

4. Interaction of the Parts

4.1 State of the Parts Prior to Loading

The pistol is on safe.

The slide is in the forward position. The breech is closed due to the inertial slide lock. The surface of the safety locks the motion of the slide on the frame.

The hammer rests on the edge of the safety and cannot move forward. The safety claw grips the recess of the hammer and locks it.

The sear is lifted through the edge of the safety pin. There is a small space between the "safe" position of the hammer and the edge of the sear.

The trigger bar with disconnecter is in its rearmost position by action of the narrow tip of the hammer spring. The disconnecter is sunken into the frame. The edge of the disconnecter responsible for cocking the hammer is connected to the hammer such that pulling the trigger does not result in cocking of the hammer.

The magazine is inserted into the frame. The follower is in the highest position. The follower tab presses on the slide lock.

4.2 Interaction of Parts During Loading

Loading of the pistol

- Insert the loaded magazine into the frame.
- Move safety to "fire".
- Pull slide back and allow to travel forward.

During insertion of the magazine into the frame, the magazine lock holds the protrusion at the rear wall of the magazine and holds it in place.

The top cartridge rests against the slide comb. The magazine follower tab does not act upon the slide lock.

When safety is moved to "fire" the hammer is unlocked. The tip of the safety pin unlocks the sear. The sear drops slightly under action of its spring and positions itself in front of the safety notch of the hammer. The lock on movement of the slide is released.

When slide is pulled backwards, the slide rotates the hammer to its rearward position. The cocking notch in the sear places itself in front of the hammer and holds it in the cocked position. The rearward motion of the slide is limited by the forward end of the trigger guard. The recoil spring is compressed. The hammer lifts the sear during its rearward rotation. The trigger bar moves forward, and part of the trigger curvature remains. When the disconnecter is lifted, its recess is pushed under the tip of the sear. By action of the magazine follower and spring the cartridges are pressed up. The top cartridge lies in front of the ejector.

When slide is released, the recoil spring pushes the slide forward, thereby pushing the top cartridge into the chamber. Once the slide reaches its most forward position, the extractor claw grasps the ring-shaped cartridge rim. The pistol is loaded, cocked, safety off, and thereby ready to fire (Picture 4.1).

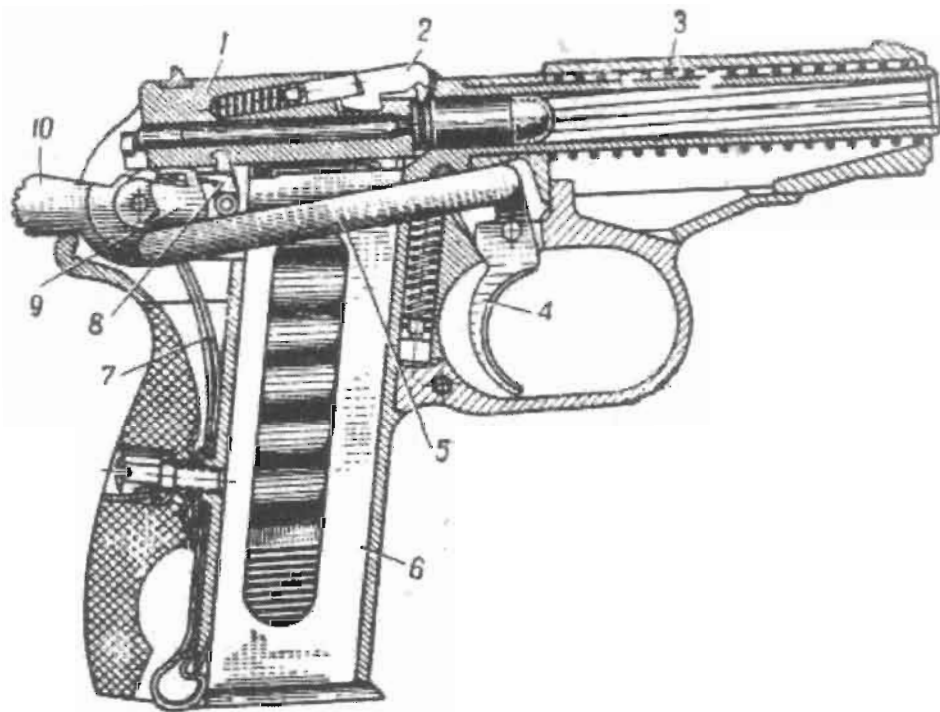

Picture 4.1 Position of Parts Prior to Firing

1 - slide; 2 - extractor; 3 - recoil spring; 4 - trigger; 5 - trigger bar; 6 - magazine; 7 - hammer spring; 8 - sear with spring; 9 - disconnecter; 10 - hammer

4.3 Interaction of Parts when Moving Safety to "Safe"

If no shot is to be fired, the pistol shall be made safe. When rotating the safety, the safety rotates the sear via a cutout on the safety. The tip of the sear releases from the cocking notch on the hammer. The hammer rotates forward (strikes) under power from the wide tip of the hammer spring and strikes the edge of the safety, which absorbs the hit.

The safety locks the motion of the slide. The safety claw locks the hammer. The pistol is safe.

If the safety is set to "fire" in this state, the hammer remains in the safe position, that is, the safety of the pistol during handling while accidental striking (impact) is assured.

Simultaneously the pistol is ready to fire with trigger cocking (cocking by activating the trigger).

4.4 Interaction of Parts during Firing

In order to fire a shot, the safety is released, the hammer cocked, and the trigger activated.

During activation of the trigger, the trigger bar is moved forward. The disconnecter rotates about the rear pin of the trigger bar and is lifted; thereby it pushes on the tip of the sear and lifts it from the hammer cocking notch.

The disconnecter grips into the slide recess.

The hammer speeds forward under power from the hammer spring and hits the firing pin. The firing pin tip strikes the cartridge primer and the shot is fired.

By pressure of the powder gases, the projectile leaves the barrel. A portion of the powder gas pressure pushes on the cartridges base and the force is transferred to the slide. The slide slides rearward.

4.5 Interaction of the Parts after the Shot

The rearward traveling slide pushes the disconnecter tip to the right and separates the disconnecter from the sear. The released sear is pushed against the hammer by the sear spring. Once the hammer has reached its rearmost position, the sear grabs the cocking notch of the hammer. The empty shell is simultaneously pulled from the chamber by the extractor and is thrown from the slide ejection port by the ejector. The recoil spring is compressed. The follower guides the next cartridge upwards. The recoil of the slide is limited by the forward end of trigger guard. The slide is pushed forward by the expanding recoil spring; thereby the slide grabs the next cartridge and pushes it into the chamber.

Before the next shot can be fired, the trigger must be released; thereby the trigger bar is moved rearward by pressure of the narrow tip of the hammer spring. The disconnecter is lowered, moves left, and rests against the edge of the sear. The pistol is ready to be fired again.

4.6 Interaction of Parts when Shooting Double Action

When activating the trigger, the trigger bar is pulled forwards. The disconnecter turns and is pressed up. The tip for cocking the hammer pushes the hammer backwards. The sear is simultaneously lifted. The sear cannot grasp the hammer cocking notch. The edge of the disconnecter releases from the hammer, the hammer strikes forward onto the firing pin and the shot is fired.

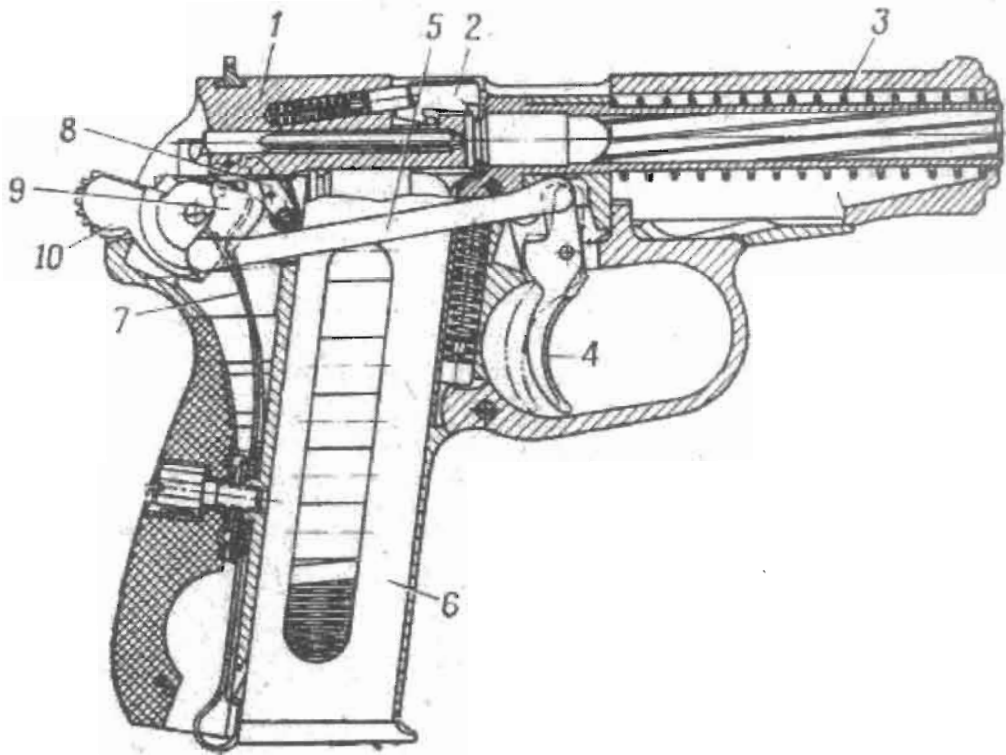

Picture 4.2 State of Parts before Firing Double Action

1 - slide; 2 - extractor; 3 - recoil spring; 4 - trigger; 5 trigger bar; 6 - magazine; 7 - hammer spring; 8 - sear with spring; 9 - disconnecter; 10 - hammer

4.7 Interaction Parts when Exhausting Magazine Contents

Once the last cartridge in the magazine has been shot, the magazine follower tab pushes the front edge of the slide lock up. The slide lock grasps the slide which, like the hammer, remains in its rearmost position. This condition remains unchanged when the magazine is removed.

Only when the slide lock is pushed down will the slide unlock and speed forward. If no cartridge is to be loaded, the slide is to be guided forward (slowed by hand).

5. Stoppages while Firing and their Resolution

5.1 General

The pistol is a reliable and functional weapon when used under typical service conditions, careful maintenance and storage. However, after long service, harsh service conditions, and lack of proper maintenance, stoppages can occur during firing.

5.2 Measures for Prevention of Stoppages

To prevent stoppages while firing, the pistol shall be:

- properly prepared for firing
- inspected and maintained in a timely fashion (observing that the pistol is clean and the moving parts are lightly lubricated),
- repaired in a timely fashion
- protected from dirt and impact while firing and in service,
- stored properly in the weapons storage room and under combat conditions.

Before loading, the cartridges shall be inspected (Section 6.4). In low-temperature conditions, the slide should be retracted and released several times; the hammer should also be cocked and decocked several times.

5.3 Stoppages, their Cause and Resolution

If a stoppage occurs during shooting, the hammer is cocked or the slide is activated. If the stoppage is not resolved, unload the pistol, look for the cause of the stoppage and resolve it.

Stoppages should never be resolved by excessive use of force.

Table 5.1: Stoppages, Causes, and Resolution

Stoppage	Cause	Resolution
<u>Misfire</u> Slide is closed. Hammer hit firing pin, but shot did not fire	<ul style="list-style-type: none"> a) Primer is defective b) Thickened lubricant or dirt in the firing pin channel c) Firing pin tip worn, firing pin or firing pin tip broken 	<ul style="list-style-type: none"> a) Rack slide and continue firing b) Inspect pistol. Clean firing pin channel and firing pin c) Submit pistol for maintenance
<u>Slide does not glide into forward position</u> ²⁴ Trigger cannot be activated	<ul style="list-style-type: none"> a) Chamber, frame guide slots, slide guide rails, or cutout in slide for bottom of cartridge are dirty b) Extractor jams and did not grasp the cartridge base, extractor spring or claw are dirty 	Strike slide forward with hand and keep firing. Inspect pistol and clean dirty parts
<u>Cartridge is not pushed into chamber.</u> Slide is in forward position or slide is in midway position with a cartridge	<ul style="list-style-type: none"> a) Magazine and moving parts of the pistol are dirty b) Upper parts of magazine are dented. Follower spring is fatigued or broken 	<ul style="list-style-type: none"> a) Rack slide and keep shooting. Clean pistol and magazine b) Change magazine. Have follower spring changed
<u>Shell is not ejected and is jammed between slide and frame</u>	<ul style="list-style-type: none"> a) Moving parts of pistol are dirty b) Extractor or ejector worn or broken 	<ul style="list-style-type: none"> a) Remove jammed shell and keep shooting; clean moving parts b) Submit pistol for maintenance

²⁴Typically called "going into battery".

Stoppage	Cause	Resolution
<u>Pistol fires automatically (sustained fire)</u>	a) Parts of the trigger and striker mechanism are dirty or covered with thickened lubricant	a) Inspect and clean pistol
	b) Hammer or tip of sear is worn	b) Submit pistol for maintenance
	c) Sear spring weak or broken	c) Submit pistol for maintenance [sic] ²⁵
<u>After firing last shot, slide goes to forward position</u>	Magazine follower tab broken	Change magazine. Have new follower installed in magazine

²⁵ Instruction is repeated in original manual (typographical error).

6. Inspections

6.1 General

Inspections are composed of assessing the state of readiness and safety as well as examination and assessment of the service readiness of the pistol. Damage should be discovered in a timely fashion and corrected. During inspections, it should be examined if

- there are traces of rust, dirt, large scratches or cracks on the parts and in what state the lubricant is,
- the slide, the trigger and striker assembly, the safety, the slide lock, and the magazine are functional,
- the magazine is securely in the frame and held by the magazine lock as well as ensuring that removal is not hindered by the lanyard,
- the bore is clean,
- the front and rear sights are in order,
- the accessories are all present.

Any deficiencies should be resolved immediately. If issues cannot be resolved in the unit, the pistol should be submitted for maintenance.

Characteristic issues that have influence on firing are as follows:

- The front sight is bent or damaged
The target hits are laterally opposite the front sight shift.
- The rear sight is shifted.
The target hits are laterally opposite the rear sight shift.
- The muzzle is damaged.
The projectile is deflected in opposite direction of the barrel damage location.
- The bore is enlarged (especially at the muzzle).
The rifling lands are worn (rounded). The rear sight is not tight.
The projectile pattern becomes larger.

6.2 Inspection before Active Duty

The inspection before active duty is typically done in assembled state. The following are to be considered:

- a) No beginnings of rust, scratches, impact marks, and cracks are allowed on parts of the pistol. The [serial] number on the slide, the safety, and the magazine must all match the number on the frame.
- b) No impact marks that hinder aiming are allowed on the front sight or in the notch of the rear sight. The rear sight must be tight in the slide notch. The groove²⁶ on the rear sight must match the groove in the slide.
- c) The safety must be easily movable and remain reliably in both positions.
- d) When releasing the hammer (pull trigger to rearmost position), the hammer must be capable of being pushed forward to the point of impact. Once this action is ended (release trigger), the hammer should rotate backwards and stay in the "safe" position. From this position, the hammer should not be able to be pushed forward.
- e) After pulling the trigger, it should return into its forward state.
- f) The trigger guard must be able to be pulled out of the frame.
- g) The grip screw must be tight.
- h) There should be no dirt, beginnings of rust, and other deficiencies. To inspect, pull the slide back and lock and look into the muzzle; to facilitate inspection, place a piece of white paper into the ejection port.
- i) The magazine (spare magazine) must be easily inserted into the frame and removed from the frame as well as be held firmly by the magazine lock. The walls and stamped parts of the magazine may not be damaged. The follower should be easily movable by hand.
- k) ²⁷ The functionality of the pistol must be ensured. For examination, the following actions are necessary:
 - make pistol safe.

²⁶ Dovetail

²⁷ In the original manual, the numbering scheme skips from item i) to k) without j). We have reproduced that here.

- Pull slide all the way back and release. After approximately 5 mm forward movement, the slide lock must hold the slide in its rear position.
- Push down on slide lock. The slide must abruptly move forward. The hammer must remain cocked.
- Activate trigger. The hammer must release from its cocking notch and hit the firing pin.
- Remove magazine from frame and fill with practice cartridges.
- Insert magazine, rack slide. The slide must rapidly move to its forward position. One cartridge must be pushed into the chamber. During every pull of the slide, one cartridge must be thrown from the ejection port.
- Make pistol safe. The hammer must be released from its cocking notch, strike the edge of the safety and be locked into this position. The motion of the slide must be locked.
- Move safety to "fire" and pull trigger. The trigger cocking must be performed.
- Cock the hammer and push on the head of the hammer. The hammer may not release from the cocking notch. The trigger release weight is to be checked with a spring scale. The release force shall not be less than 1.5 kp and not more than 3.5 kp.

1) Testing of the hammer blocking by the edge of the safety.

For testing, the following actions are required:

- Move safety to "fire."
- Cock hammer.
- Hold pistol with muzzle down and watch the sear through the notch in the slide.
- Slowly rotate safety lever up until the sear lifts.
- Determine the position of the safety the moment the sear lifts.

- Hold the hammer, activate the trigger and slowly let the hammer rotate forward. The hammer must touch the edge of the safety, i.e. the shot cannot be fired.

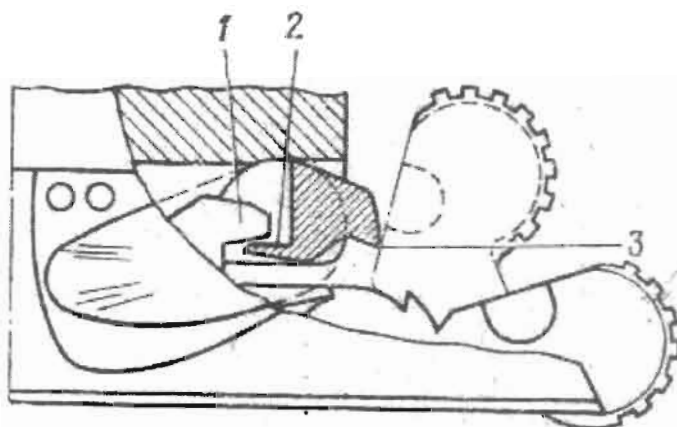

Picture 6.1 Method of hammer blockage by the edge of the safety

1 - edge of the safety lever; 2 - edge of the safety; 3 - safety claw

- m) The accessories must be clean and complete. There must be no burrs on the end of the pull-through weight (tip of the cleaning rod). The cleaning rod must not be bent or damaged. The condition of the seams and loops of the holster must be examined. The lanyard must be in order and properly fastened.

6.3 Inspection during Active Duty

The inspection during active duty is carried out during breaks in combat and troop movement. It encompasses an external inspection of the pistol.

The following are to be observed:

- a) The parts may not show any damage that prevent use.
- b) Extreme dirt contamination that leads to stoppages is not allowed.

In addition, the functional readiness is to be examined. Any deficiencies that are discovered are to be remediated immediately or after active duty.

6.4 Inspection of the Cartridges

Deficiencies that lead to stoppages while firing should be determined. The cartridges are to be inspected before filling the magazine or by special instruction. The following should be observed:

- scratches, uneven spots, cracks, or bent surfaces that could hinder the insertion of the cartridge into the chamber,
- green discoloration (especially on the primer),
- cartridges where the projectile is loose in the shell or can be separated from the shell by hand,
- primers that protrude beyond the cartridge base.

Cartridges that exhibit these deficiencies are to be collected and turned in. If the cartridges are dusty, dirty, or covered with corrosion or rust, these should be rubbed off with a clean cloth.

6.5 Preparation of the pistol for firing

The pistol is prepared for firing in order to ensure error free employment of the pistol while firing.

To that end, the following is must be carried out:

- Inspect pistol (according to section 6.2),
- Clean barrel and rub dry,
- Inspect functional safety (according to section 6.2),
- Inspect cartridges (according to section 6.4),
- Fill magazine (according to section 9.2).

7. Maintenance and Storage

7.1 General

The pistol shall constantly be kept clean and ready for active duty. This is achieved through proper maintenance, careful use, and proper storage.

Soldiers and non-commissioned officers that are equipped with this pistol shall carry out maintenance work under supervision of the sargeant at arms. He determines the degree of disassembly, the quality of the cleaning, and allows or inspects the reassembly and lubrication of the pistol.

Officers maintain their pistols by themselves.

7.2 Inspection after active duty

The inspection after active duty is carried out:

- during appropriate breaks under combat conditions and while on extended training missions (generally once per day),
- immediately after practice, duty, and training in the field,
- after firing.

After multiple use of the pistol per day, the maintenance should be done only once.

Maintenance after active duty encompasses:

- cleaning and lubrication of the pistol (section 7.3),
- functional inspection of the parts groups, mechanisms, and accessories (section 6.2).

The extent of the maintenance activities is determined by the extent of use and the degree of soil accumulation in the pistol.

7.3 Cleaning and Lubrication

For cleaning and lubrication, gun oil, cleaning rag, and cleaning patches are to be used.

For cleaning of notches, holes, cutouts and the like, wooden rods may be used.

The cleaned and dried metal parts are to be lightly lubricated immediately after cleaning.

The pistol is cleaned as follows:

- a) Prepare maintenance materials.
- b) Inspect accessories.
- c) Disassemble pistol.

Typically the pistol is partially disassembled. After firing and when extensively soiled, the pistol shall be fully disassembled.

- d) Clean pistol.

Clean bore.

- Dribble gun oil onto cleaning patch and with the cleaning pull-through (cleaning rod), pull the patch through bore starting from the muzzle.
- Change patch and repeat.
- Dry bore; first with patch, then with a dry, clean white cloth.
- Continue cleaning bore until the white cloth remains clean.
- Inspect bore and chamber.

Cleaning of the remaining parts (mechanisms) of the pistol

The remaining parts (mechanisms) are to be cleaned with a dry cloth, brush, and wooden rods. All remnants of dirt, moisture, beginnings of rust and powder remains shall thereby be removed.

Remove all rust and powder remains with gun oil.

After cleaning, all parts should be rubbed dry. The cleanliness of notches, holes, edges, etc. should be especially noted.

- e) Lubricate pistol.

Pull an oil sprinkled cleaning patch or cloth through the bore multiple times. The lands and grooves of the bore must be covered with a thin even film of oil.

The surfaces of metal pieces should be lightly lubricated with a cloth. For lubrication of notches, holes, etc. wrap a cloth around a wooden rod.

Observe!

Over application of oil accelerates dirt accumulation and can cause stoppages.

- f) Assemble pistol and inspect functionality.
- g) Clean parts of the cleaning kit and repackage.
- h) Wipe down holster.

Note:

A pistol that was subjected to frost and then brought into a warm room should not be lubricated before it has "sweated out." If water droplets form, the parts should be wiped dry and lightly lubricated.

7.4 Periodic Maintenance

Periodic maintenance should be done at least monthly during storage. It encompasses:

- inspection of the cleanliness state of the pistol and accessories,
- inspection of the completeness of the accessories,
- cleaning the pistol according to determined deficiencies.

The pistol should be partially disassembled for periodic maintenance.

7.5 Technical Maintenance No. 1

Technical maintenance No. 1 is to be completed twice per year by the pistol carriers under direction of the non-commissioned officers of the rocket and weapons technical detail. It encompasses:

- the inspection of the technical and maintenance state of the functional groups, parts, and mechanisms of the pistol and accessories,
- the cleaning of all parts of the pistol in the fully disassembled state,
- the inspection and restoration of functionality of the functional groups, parts, and mechanisms of the pistol.

Order of actions:

- a) Completely disassemble pistol. Degrease parts, clean, and rub dry.
- b) Confirm that part numbers match and that accessories are complete.
- c) Inspect parts carefully in order to determine if they are bent, scratched, dented, gouged, rusted or dirty.

Inspection of the frame with barrel and trigger guard

The surfaces of the frame and the slots for movement of the slide must not be damaged. The threads for the grip screw must not be stripped. The barrel must be firmly seated in the frame. The trigger guard must be spring loaded.

During inspection of the barrel, it should be noted that the bore and the chamber are clean and the muzzle is undamaged. Hold the barrel at eye height and point towards a light colored background. It should be inspected first from the muzzle and then from the chamber end. Turn the barrel about its axis.

For non-chrome lined barrels the following should be noted:

- Signs of rust formation (dark dots or spots at individual areas or the entire barrel),
- Rust (dark areas on the metal). Rust that is not identifiable by the naked eye can be found when the bore is swabbed with a clean cloth (rust leaves behind yellow spots),
- Traces of rust pitting (dark, shallow spots, that remain after rust removal),
- Deep rust pitting (only to be removed by the weapons shop),
- Copperizing (reddish areas). Only to be removed by the weapons shop,
- Scratches, streaks. It is forbidden to remove scratches in the bore,
- Barrel rings (shadows of lateral rings - half rings in the bore or swelling in the exterior surface of the barrel). Barrels with swelling are not to be used if shooting conditions do not warrant usage.

Inspection of the slide with firing pin, extractor, and safety.

The guide rails, edges, and recesses must not be dirty or peined. The firing pin must be freely movable in the firing pin channel. The ejector must not be worn, the extractor must not be worn or damaged, and the extractor spring must not be compressed or broken.

The firing pin tip must not be damaged or bent, front and rear sights must not be damaged or misaligned, and the recoil spring must not be compressed or broken. The recoil spring must not show signs of rust and must be firmly attached to the barrel.

Inspection of the Trigger and Firing Mechanism

The parts of the trigger and firing mechanism must not be peined, bent, broken, or sheared. The notches, edges, and detents must not be peined, worn, or broken.

The disconnecter must move freely on the trigger bar pin.

The trigger spring must have sufficient cocking power and the main spring must not be broken.

The safety detent spring must engage both safety positions.

The blocking edge of the hammer must not have large impact wear and the edges of the safety pin must not be worn.

Inspection of the Grips with Grip Screw

The grips must not be torn or cracked and the threads of the grip screw must not be damaged. The metal screw bushing must be firmly seated in the grip.

The lanyard must be inserted correctly and must not be pinched.

Inspection of the Slide Release

The slide release must not be bent and the ejector must not be worn or broken.

Inspection of the Magazine

The magazine housing and the follower must not be bent, the follower spring must not be compressed, and the follower tab

for activating the slide catch as well as the magazine release must not be worn. The accessories must be complete and ready for active duty.

- d) Any deficiencies in the cleanliness status are to be rectified by pistol carriers and technical deficiencies of NCOs of the rocket and weapons technical service. Missing accessories are to be replaced.
- e) The parts of the pistol are to be lightly lubricated and the pistol reassembled.
- f) Test the functionality of the pistol.

7.6 Technical Maintenance No. 2

Technical maintenance No. 2 is done by maintenance forces of the troop divisions or the unit based on special documentation. It includes the tasks of Technical Maintenance No. 1. After every Technical Maintenance No. 2, the pistol is to be completely disassembled and cleaned two to three times on consecutive days.

7.7 Storage of the Pistol and the Cartridges

Storage is the warehousing of duty-ready and serviced pistols and ammunition based on DV 050/0/001 "Rocket and Weapons Technical Service". The storage of the pistol and accessories is the responsibility of the army member, who is outfitted with a pistol. He is required to use the pistol carefully and maintain and inspect the pistol according to these specifications.

During field training, marching, and transport by train and vehicle, the pistol is to be carried on the person as per these specifications. During short stays in a town in quarters, the pistol can remain with the weapons carrier if not otherwise instructed.

It is prohibited to close the barrel or stuff anything inside the barrel.

The pistol shall always be carried or stored on "safe".

8. Adjustments and Sighting

8.1 General

All pistols shall be adjusted, i.e. sighted in. The inspection of adjustments, i.e. sighting shall be carried out:

- when accepted by the troop division, however not when delivered by the manufacturer (see accompanying documents),
- after maintenance on the sights,
- after determination of unusual deviations while shooting,
- during combat conditions (when required) at an advantageous time, as determined by a commander.

8.2 Adjustment

8.2.1 General

The adjustment of the pistol is done with the adjustment specification for marksmen's weapons (JAS-72). The order of tasks is discussed in the educational manual "Adjustment and Sighting of Marksmen's Weapons and Tank-MG". Tasks with the adjustment specification are done by the Rocket and Weapons Technical Service. Only duty-ready pistols may be adjusted.

The sighting distance is 25m. The adjustment mechanism can be used in any weather (except for poor visibility) and in an ambient temperature of -10°C to +40°C. The bullseye can be illuminated after dark.

8.2.2 Principle of Sighting

During sighting, the adjustment of the sight assembly is done with an angle telescope and a bullseye. The extrapolated barrel axis is projected onto the lowest mark on the bullseye using the elevation and windage correction of the adjustment mechanism. By changing the rear sight, the upper mark of the bullseye is then sighted. If both adjustment points are in line with the appropriate marks on the bullseye, the pistol is sighted in.

8.3 Live Fire Sighting

8.3.1 General

Live fire sighting shall be carried out by officers or by outstanding marksmen, if possible in the presence of the army member. Superiors, up to and including commander of the troop division, are responsible for ensuring exact compliance with rules of pistol inspection and correct sighting.

Before live fire sighting, the pistols shall be thoroughly inspected and any deficiencies found are to be corrected. During live fire sighting, the master armorer shall be present with necessary tools. Live fire sighting shall be done under advantageous conditions (clear skies, calm wind conditions or in a closed shooting stand, i.e. a wind protected area of the shooting range).

8.3.2 Live Fire Sighting Conditions for Pistol M

Position:	Sitting at the shooting table or prone, grip resting on a sand bag.
Distance:	25 m
Cartridges:	4
Sighting Target:	1 m x 0.5 m
Bullseye:	Black circle, 25 cm diameter
Holding Point:	Center of bullseye (it is advantageous to mark the center ahead of time)
Control Point:	Center of bullseye
Control circle:	15 cm diameter

Note:

The weapon is acceptable when at least 3 hits are inside the control circle and the center point of impact is not further than 5 cm from the control point.

If the center point of impact is more than 5 cm from the control point, the rear sight must be changed. If the center point of impact is too high, a smaller rear sight shall be installed. If the center point of impact is too low, a larger rear sight shall be installed. If the center point of impact is too far left, the rear sight shall be moved to the right. If the center point of impact is too far right, the rear sight shall be moved to the left. A rear sight sideways adjustment of 1.5 mm is allowable.

The front sight shall not be filed down.

After live fire sighting, the rear sight shall be fastened with a staking tool. The old marking shall be erased and in its place, a new marking shall be impressed on the rear sight.

9. Handling of the Pistol While Shooting

9.1 General

Shooting of the pistol is done in the positions (hold) of standing, kneeling, prone, or while moving, i.e. from a vehicle either free hand or rested. All actions while shooting shall be done quickly, without interrupting the view of the target.

Shooting of the pistol includes:

- direct preparation for shooting (loading the pistol, and taking position for shooting),
- taking the shot (aim and activate trigger),
- finishing shooting (release trigger, secure pistol and unload).

During battle, fire is to be done independently. In the interest of training, shooting positions will be dictated, e.g.: "Towards (target to be determined), Prone (kneeling, standing) - Fire!" Upon this command, the appropriate stance is to be taken, the pistol safety released, aim, and a shot to be fired with trigger cocking (double action).

The shot can also be fired by first cocking the hammer (single action). In this case, after the hammer is cocked, one should aim and activate the trigger.

While shooting during training, the established specifications of DV 250/0/005 "Shooting with Marksmans' Weapons" are to be observed.

9.2 Direct Preparation for Shooting

9.2.1 Filling the Magazine

Upon the command: "Load!" ("To Battle!") the shooter shall:

- remove the pistol from the holster (or pocket of the field duty suit), remove the magazine from the frame and return the pistol to the holster,
- load the magazine with cartridges (Picture 9.1),
- remove the pistol from the holster and insert the magazine into the frame,



Picture 9.1 Loading the Magazine

- insert one cartridge into the chamber by releasing the safety, pulling the slide to the rear most position and releasing it,
- engaging the safety and insert the pistol into the holster.

9.2.2 Positions (Stances) for Shooting

To take the position shooting standing (Picture 9.2):

- make a half turn to the left, advance the right foot in the direction of the target by one shoulder width, and distribute body weight evenly onto both feet,
- open the holster and remove the pistol,
- hold the pistol up with muzzle vertical in eye height, release safety with the right thumb, and place index finger into the trigger guard without touching the trigger.

To take the position shooting kneeling (Picture 9.3):

- move the left foot to the rear such that the tip of the foot is across from the calf of the right foot,
- drop quickly onto the left knee and sit on the calves,
- keep the right leg vertical, the tip of the foot pointing in the direction of the target,
- remove the pistol from the holster and continue as described in "shooting standing"



Picture 9.2 Position for Shooting Standing



Picture 9.3 Position for Shooting Kneeling

To take the position shooting prone (Picture 9.4):

- take a full step forward and right and lie down,
- remove the pistol from the holster and continue as described in "shooting standing"

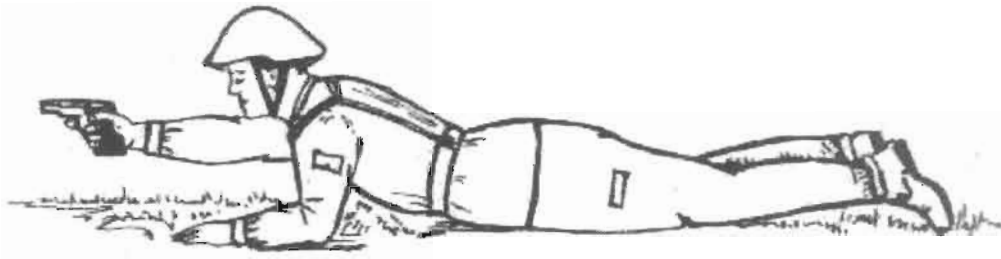

Picture 9.4 Position for Shooting Prone

9.3 Opening Fire and Ceasing Fire

9.3.1 Opening Fire

To open fire from all positions (stances)

- select hold point,
- extend the right hand with the pistol without interrupting view of target,
- place the first joint of the index finger onto the trigger with the thumb on the left side of the frame (Picture 9.5),
- hold the extended hand free without tension, thereby the surface of the hand, the barrel, and the elbow must be in a single plane (Picture 9.6).



Picture 9.5 Holding the Pistol while Shooting



Picture 9.6 Standing Position, Freehand Stance

During aiming, the shooter shall hold his breath during normal exhalation, close his left eye, make a straight line with the front and rear sights onto the hold point and simultaneously activate the trigger. If a shooter has difficulty closing the left eye, it is permitted to aim with both eyes open.

To activate the trigger, evenly pull on the trigger with the first joint of the index finger while holding your breath until (unbeknownst to the shooter) the shot breaks.

While arcing the trigger, the pressure of the finger must be made in a straight line. The shooter must evenly increase the pressure on the trigger and should not be confused by oscillations in the line of sight. The desire to release the shot at the best agreement with the line of sight and the holding point has the consequence of shot expectation and thereby an inaccurate shot (flinching). When the shooter feels that during arcing of the trigger he can no longer hold his breath, he should, without increasing or decreasing the pressure,

take a breath, hold his breath anew, and continue arcing the trigger evenly.

9.3.2 Ceasing Fire

Fire can be ceased temporarily and completely. For temporary cease fire the command "Fire halt"! shall be given. Upon this command, the shooter shall release the trigger, engage the safety, and, if necessary, reload the pistol such that, at a given time, shooting can continue.

For complete cease fire the command "Fire halt - unload!" shall be given. Upon this command the shooter shall:

- release the trigger,
- engage the safety,
- unload the pistol.

To unload the pistol

- remove the magazine from the frame,
- release the safety,
- remove the cartridge from the chamber, for which the pistol frame shall be held with the right hand, the slide pulled back with the left hand and then released, the ejected cartridge to be retrieved and wiped off with a cloth.
- engage the safety,
- remove the cartridges from the magazine, for which the magazine is held in the left hand, and the cartridges are removed with the right thumb by pushing the cartridges forward one after the other and caught (Picture 9.7),
- remove the pistol from the holster, insert the magazine, return the pistol to the holster, and close the holster.



Picture 9.7 Removal of Cartridges from the Magazine

Upon the command: "Weapons Check!" the shooter shall

- remove the magazine from the frame with the left hand and place it under the thumb of the right hand in front of the safety (Picture 9.8), such that the magazine follower is 2 to 3 cm higher than the slide,
- after the leader has checked the pistol, take the magazine into the left hand,
- release the slide by pressing on the slide release with the right thumb,
- activate the trigger as a control release,
- activate the safety,
- insert the magazine into the frame,
- insert the pistol into the holster and close the holster.



Picture 9.8 Position of the Pistol and Magazine in the Hand upon the Command "Weapons Check!"

Note:

During fire training the actions "unload" and "weapons check" are done sequentially with the command "Unload - Weapons Check!"

9.4 Shooting from Cover Freehand and with Pistol Rest

Pistol rests are used to increase the efficiency of fire. Depending on the height of the rest, the shooter shall adjust to an appropriate position of fire. While shooting from a rest, the right hand is to be positioned such that it is on the rest, but the pistol does not touch the rest. Cover shall be used to make observation by the opponent difficult and to protect from his fire. While shooting freehand from cover, an appropriate position (standing, kneeling, prone) shall be taken and the right hand placed such that the hand and the pistol are free to move (Pictures 9.9 and 9.10).

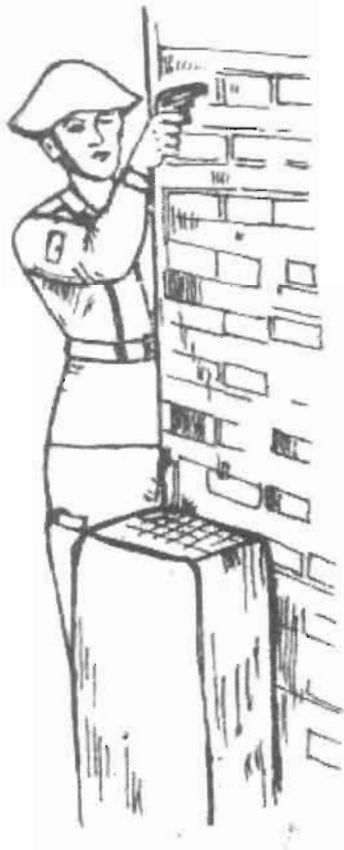

Picture 9.9 Position Shooting
Standing from
Cover, Freehand
Stance



Picture 9.10 Position for
Shooting Kneeling
from Cover, Pistol
Resting Stance

10. Rules of Shooting

10.1 General

The army member that is armed with a pistol fires independently depending on the situation. Shooting is characterized by the contents of Table 10.1.

Table 10.1 Characteristics of Shooting

Distance in m	Position of the average flight path in cm (sighted in at 25m)		Diameter of Pattern in cm	
	Elevation increase of the center point of impact at 12.5cm above the hold point	Center point of impact is on hold point	100% of shots	50% of shots
10	+ 5.0	0	3.5	2.0
15	+ 7.8	+0.3	5.0	3.0
20	+10.2	+0.2	6.5	4.0
25	+12.5	0	7.5	4.5
30	-13.9	-0.5	9.0	6.0
40	+16.0	-2.5	12.0	7.0
50	+16.8	-5.7	16.0	8.0

Note:

The sign plus (+) and minus (-) indicates the position of the flight path above and below the line of sight.

10.2 Selection of Location, Target, and Hold Point

The shooting of the pistol is done at various location as well as various positions and stances to facilitate destruction of the target is the shortest possible time.

During battle the location of fire is to be independently determined by the shooter.

During selection of location for shooting, the layout and terrain conditions are to be considered. The selected location for shooting should facilitate convenient handling, maximum impact of fire, and cover from opposing fire.

Targets for pistol shooting are individual soldiers and officers of the opponent (live forces) that suddenly appear or are moving. Selection of targets should be those that are closest and those that are the most vulnerable. Selection of the hold point should be made with consideration for the distance to target and the height of the flight path according to Table 10.1.

While shooting at stationary target at distances of up to 50 m, the hold point is always to be made with consideration of the location of the target and its height.

Targets moving towards the shooters are to be treated the same as stationary targets. For destruction of targets that are moving at an angle to the direction of fire, the hold point is to be held in front of the target with consideration of the target's speed. Shooting at temporarily viewable or suddenly appearing targets is to be done with trigger cocking (double action) and immediate opening of fire.

10.3 Shooting at Night and with Limited View as well as under Influence of Chemical Agents

Shooting at night and under artificial illumination requires considerable skill and flexibility from the shooter in order to fire a shot in the shortest possible time. When terrain is illuminated the shooter must quickly find the target and deliver the shot suddenly, or deliver a series of shots depending on the length of the illumination.

During twilight and bright (moonlit) nights, the same rules as daylight are to be followed.

At night, when there is not possibility of illumination of the target and for aiming, fire shall be directed at suspicion of silhouettes or in the direction of sudden fire and other noises made by the opponent.

Shooting under influence of chemical or nuclear agents shall be done with properly donned protective gear. The rules of shooting of various targets are the same as under normal conditions.

9-mm Pistol Cartridge

The cartridge consists of the case, the primer, the propellant, and the projectile.

The case serves to hold the propellant and to connect all parts of the cartridge. During firing, the case prevents gases from escaping out of the barrel via the chamber.

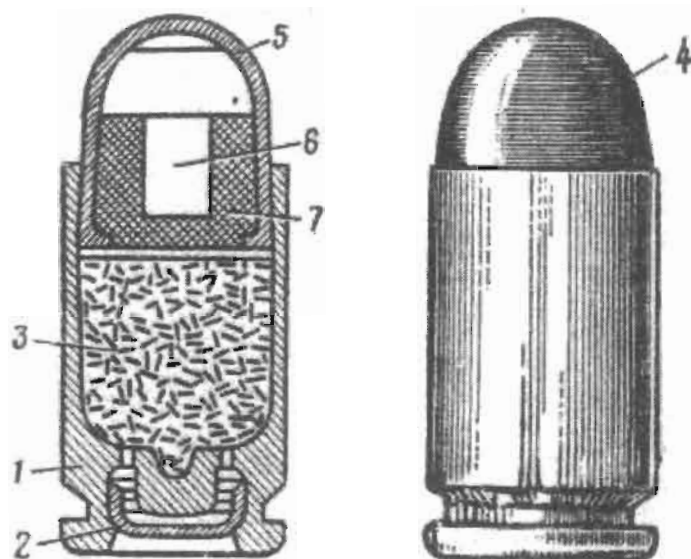

Picture A 1.1 Construction of the 9mm Pistol Cartridge

1 - Case; 2 - Primer; 3 - Propellant; 4 - Projectile; 5 - Steel Case; 6 - Steel Core; 7 - Lead Layer

In the case bottom are:

- the primer,
- the anvil, onto which the firing pin crushes the primer,
- two flash holes, through which the flames of priming charge travel to the propellant charge.

On the case bottom is a ring shaped rim for the extractor.

The propellant charge consists of a Pyroxillin powder. The primer serves to ignite the propellant charge. It consists of a brass lid with pressed impact charge and a foil ring that protects the charge. The impact of the

firing pin ignites the priming charge.

The cartridges package in structured wooden crates containing 3,200 pieces each. Each crate contains 2 welded or soldered zinc containers.

The cartridges are packaged in cartons containing 16 cartridges. Each zinc container holds 80 cartons. The inscription on the side walls of the wooden crates indicates the nomenclature of the cartridges.

It contains:

- number of the cartridge series,
- month and year of manufacture of the cartridges and the powder,
- manufacturing plant,
- mark and series of the powder,
- number of cartridges in the crate.

The mass of one crate with cartridges is approximately 37 kg.